

THIS DOCUMENT AND THE DATA DISCLOSED HEREIN OR HEREWITH IS NOT TO BE REPRODUCED, USED, OR DISCLOSED IN WHOLE OR IN PART TO ANYONE WITHOUT THE PERMISSION OF HARTFORD EICHENAUER, INC.

REVISIONS			
LTR/NO	DESCRIPTION	DATE	APPROVED
1	PRODUCTION RELEASE (WAS P1106)	5/12/03	SJH
2	REV'D AND REDRAWN PER ECN 015-10	3/29/10	SJH
3	REVISED PER ECN 010-13	1/07/14	SJH

NOTES:

1. DIMENSIONS IN INCHES
2. FLANGE MATERIAL: STEEL
3. SHEATH MATERIAL: STAINLESS STEEL
4. TERMINAL PINS: #10-32 WITH NUTS AND WASHERS AS SHOWN. TOP NUTS TIGHTENED TO 25 IN-LBS
5. COLD RESISTANCE:  $8.5\Omega \pm 10\%/-5\%$  (8.1 - 9.3) PER TUBE
6. BUSS TO BUSS RESISTANCE:  $5.6\Omega \pm 10\%/-5\%$  (5.4 - 6.2) WHEN ASSEMBLED L1-L2-L3
7. SHEATH WATT DENSITY: 125 W/IN<sup>2</sup>
8. UL FILE: E76225 MODEL: 950-30-11
9. WIRING DIAGRAM: WDG-001

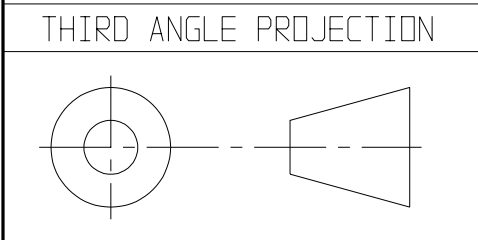
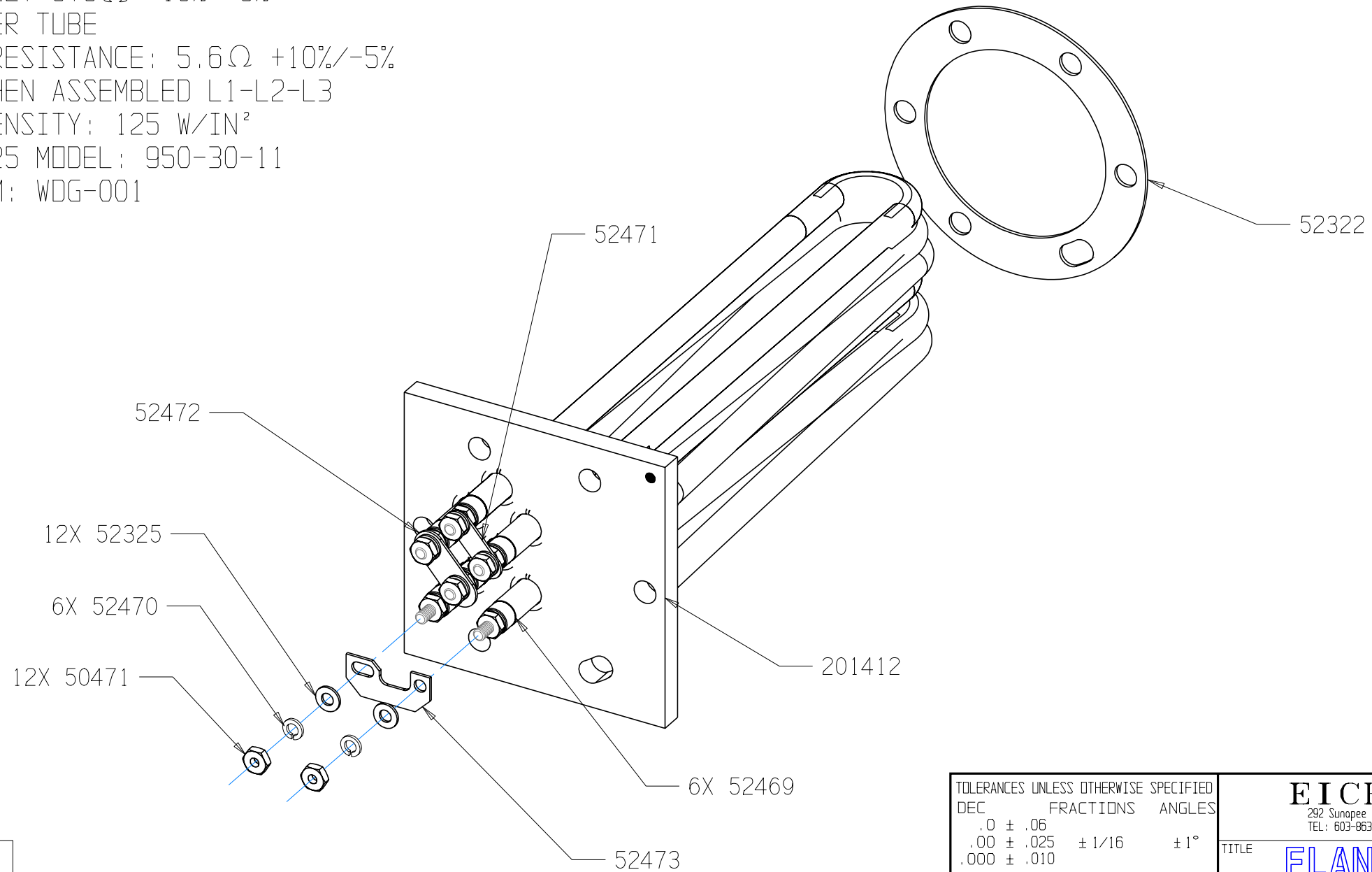

TOLERANCES UNLESS OTHERWISE SPECIFIED		<b>EICHENAUER INC.</b>			
DEC	FRACTIONS	ANGLES	292 Sunapee St., Newport, NH 03773 TEL: 603-863-1454 FAX: 603-863-1248		
.0 ± .06		± 1°	TITLE <b>FLANGED BOILER HEATER</b>		
.00 ± .025	± 1/16		240V 20KW 3PH		
.000 ± .010			SIZE B	FSCM NO.	REV. 3
APPROVALS		DATE	DWG. NO.	300473H	
DRAWN S. HEBERT		5/12/03	SHEET 1 of 2		
CHECKED			SCALE 1:2		

THIS DOCUMENT AND THE DATA DISCLOSED HEREIN OR HEREWITH IS NOT TO BE REPRODUCED, USED, OR DISCLOSED IN WHOLE OR IN PART TO ANYONE WITHOUT THE PERMISSION OF HARTFORD EICHENAUER, INC.

REVISIONS			
LTR/NO	DESCRIPTION	DATE	APPROVED
1	PRODUCTION RELEASE (WAS P1106)	5/12/03	SJH
2	REV'D AND REDRAWN PER ECN 015-10	3/29/10	SJH
3	REVISED PER ECN 010-13	1/07/14	SJH

NOTES:

1. DIMENSIONS IN INCHES
2. FLANGE MATERIAL: STEEL
3. SHEATH MATERIAL: STAINLESS STEEL
4. TERMINAL PINS: #10-32 WITH NUTS AND WASHERS AS SHOWN. TOP NUTS TIGHTENED TO 25 IN-LBS
5. COLD RESISTANCE:  $8.5\Omega \pm 10\%/-5\%$  (8.1 - 9.3) PER TUBE
6. BUSS TO BUSS RESISTANCE:  $5.6\Omega \pm 10\%/-5\%$  (5.4 - 6.2) WHEN ASSEMBLED L1-L2-L3
7. SHEATH WATT DENSITY: 125 W/IN<sup>2</sup>
8. UL FILE: E76225 MODEL: 950-30-11
9. WIRING DIAGRAM: WDG-001

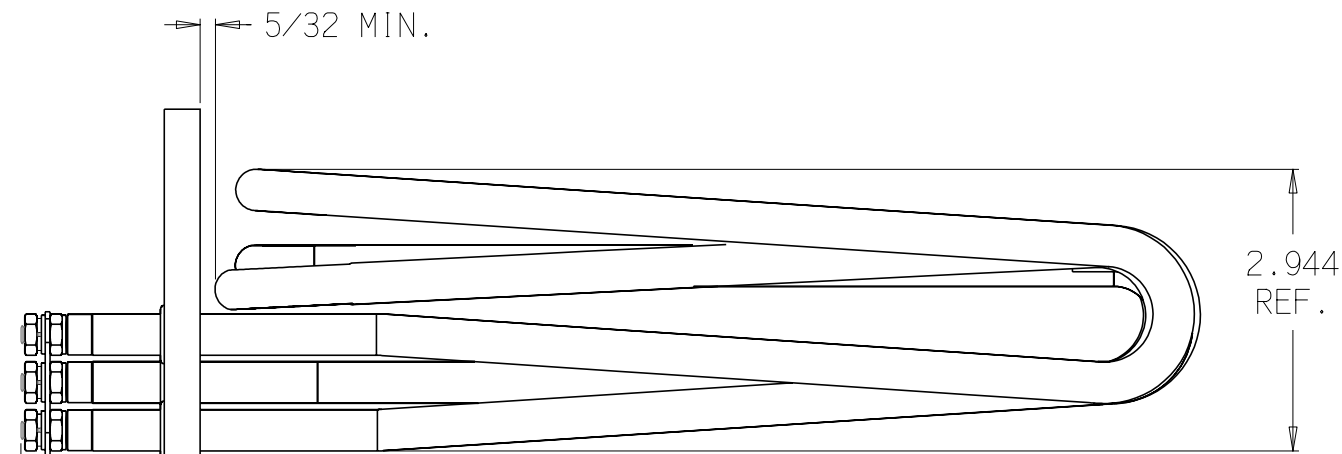
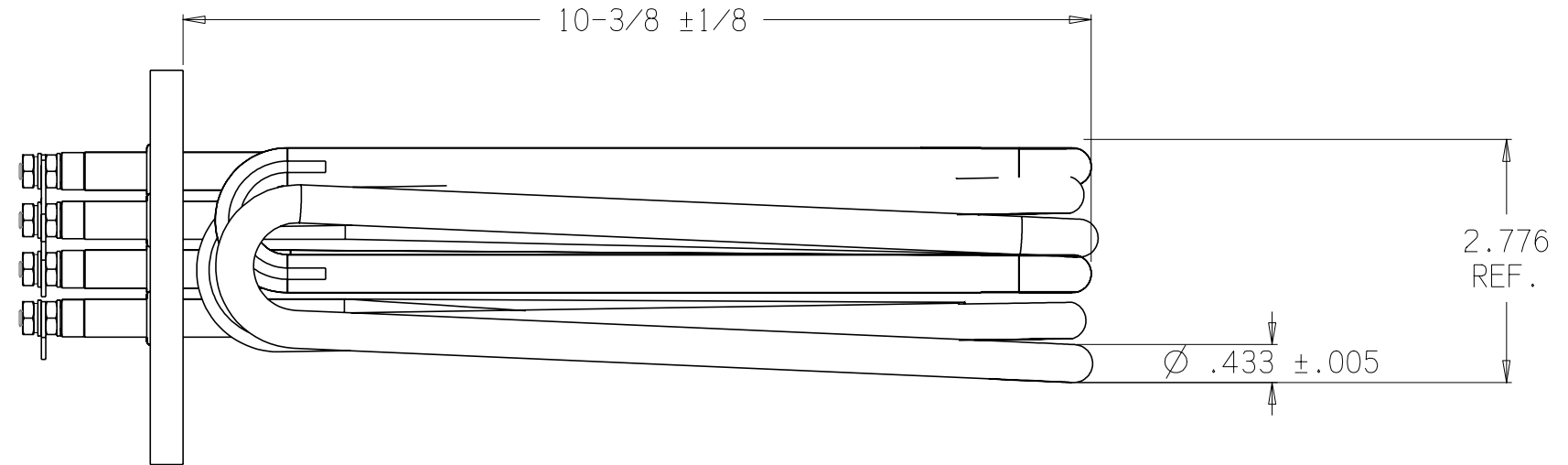

(6) 3/8 HOLES ON 3-13/16 DIA. BC

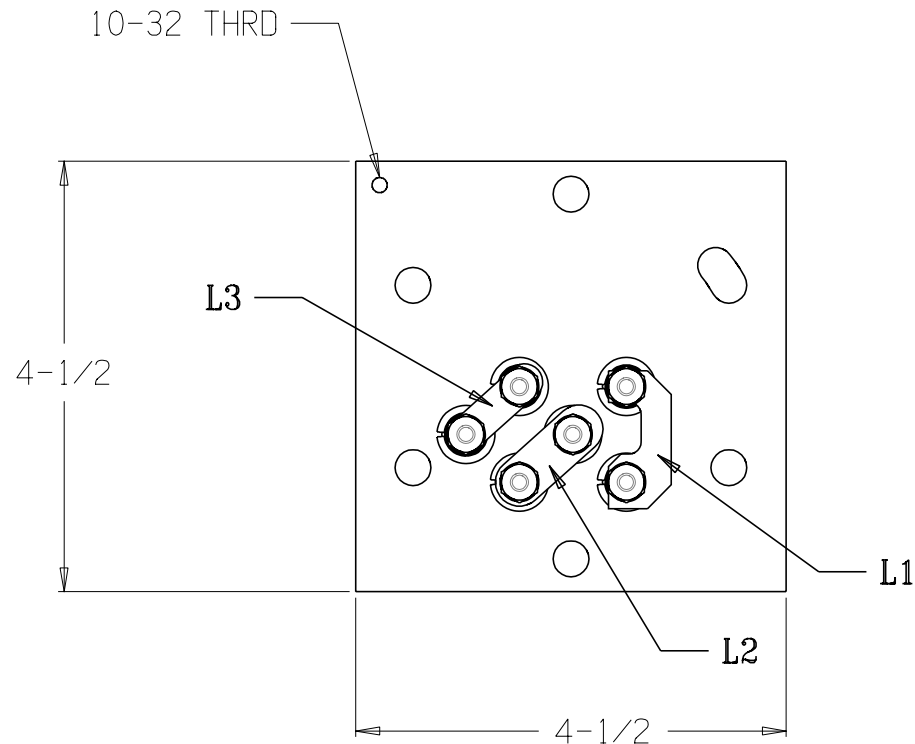
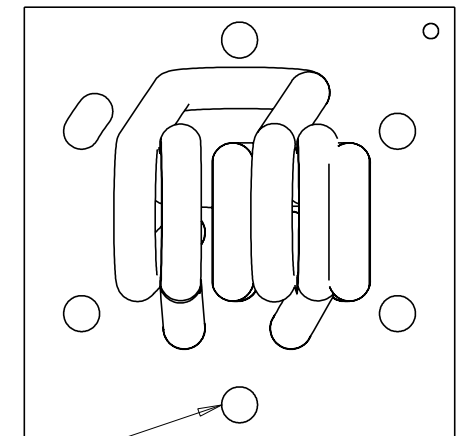

3/4 MIN.

3/8  
3/4 ± 1/8

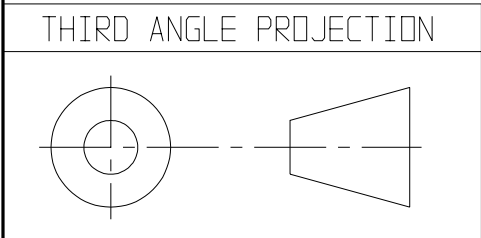

TOLERANCES UNLESS OTHERWISE SPECIFIED DEC FRACTIONS ANGLES .0 ± .06 .00 ± .025 ± 1/16 ± 1° .000 ± .010		<b>EICHENAUER INC.</b> 292 Sunapee St., Newport, NH 03773 TEL: 603-863-1454 FAX: 603-863-1248			
APPROVALS DRAWN S. HEBERT CHECKED		DATE 5/12/03		TITLE <b>FLANGED BOILER HEATER          240V 20KW 3PH</b>	
SCALE 1:2		SIZE FSCM NO. 		DWG. NO. <b>300473H</b>	
		SHEET 2 of 2		REV. <b>3</b>	